

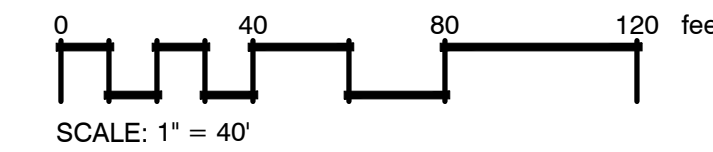

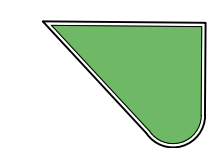







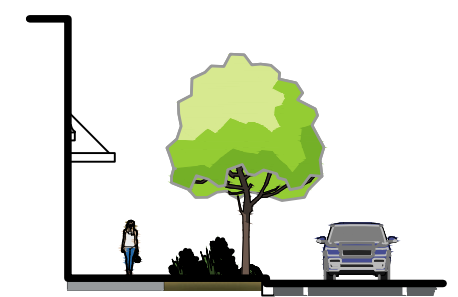











**CONCEPT GRAPHICS SCHEDULE**

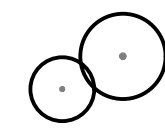

-  New Planting Area 
  -  Proposed Sidewalk Adjacent to Building with Plantings 
  -  Existing Concrete Sidewalk 
  -  Proposed Concrete Sidewalk 
  -  Proposed Concrete Crosswalk 
  -  Proposed Painted Crosswalk 
  -  Proposed Painted Sidewalk through Parking Area 
  -  Enhanced Intersection for Pedestrian safety 
  -  Proposed Parking Lot Shade Tree
  -  Existing Trees to Remain
  -  Parcel Boundary
  -  Future Trail Connection
  -  Bike Rack
  -  Phase 1 Line
  -  Phase 2 Line
- AREA WITHIN PROJECT LIMITS (FULL COLOR)

AREA OUTSIDE OF PROJECT LIMITS (SCREENED)
- PARKING AREAS IN PHASE 1 AND PHASE 2 WORK AREAS SHALL BE SEALED AND STRIPED AS PART OF PHASE 1 WORK

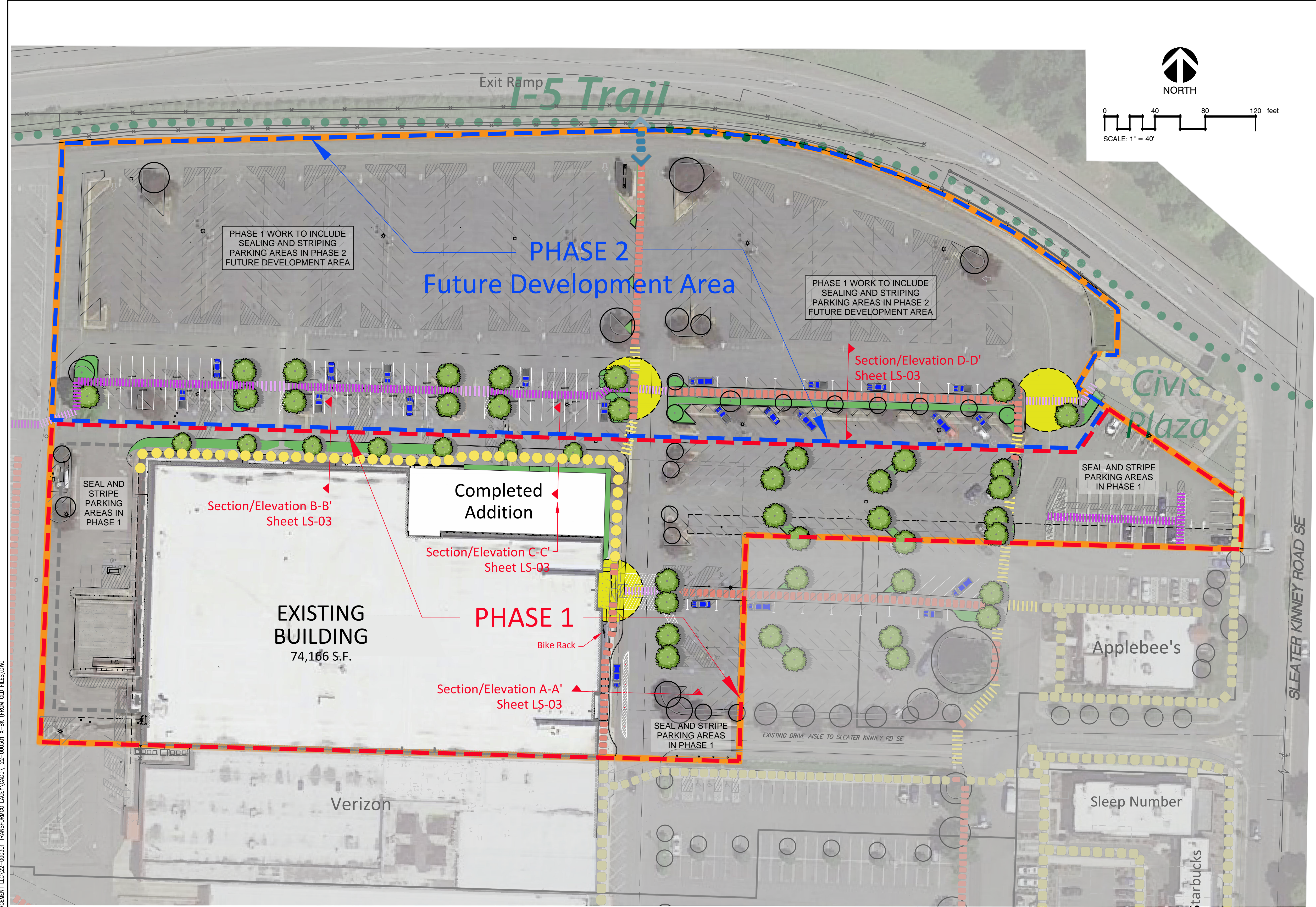

Aug 17, 2023 11:28:14am - User: ahl@scj.com  
 PROJECTS\2023 TRANSFORMCO LACEY\CADD\22-000301 X-BK (FROM OLD FILE).DWG

REVISIONS	DATE	BY	DESIGNED BY:	ISSUE DATE:	ALL DIMENSIONS SHOWN IN FEET UNLESS OTHERWISE DESIGNATED
			A. VOS	AUGUST 2023	
			DRAWN BY:	JOB No.:	
			A. VOS	22-000301	
			APPROVED BY:	DRAWING FILE No.:	
			J. GLANDER	_22-000301 X-BK (from old files)	

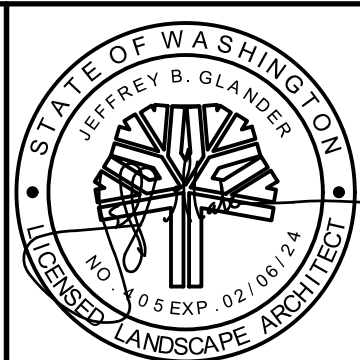

  
**SCJ ALLIANCE**  
 CONSULTING SERVICES  
 8730 TALLON LANE NE, SUITE 200, LACEY, WA 98516  
 P: 360.352.1465 F: 360.352.1509  
 SCJALLIANCE.COM

PROJECT NAME:  
**CONNECTIVITY PLAN  
 TRANSFORMCO  
 LACEY, WASHINGTON**

**CONCEPTUAL LANDSCAPE PLAN**  
**SUBJECT PARCEL LEVEL PLAN**

DRAWING No.:  
**LS-01**  
 SHEET No.:  
**1 OF 3**

# CONCEPT\_GRAPHICS\_SCHEDULE

- Existing Trees to Remain
- Proposed Parking Lot Shade Tree
- Parcel Boundary
- Phase 1 Line
- Phase 2 Line
- Future Trail Connection

New Planting Area



Existing Concrete Sidewalk

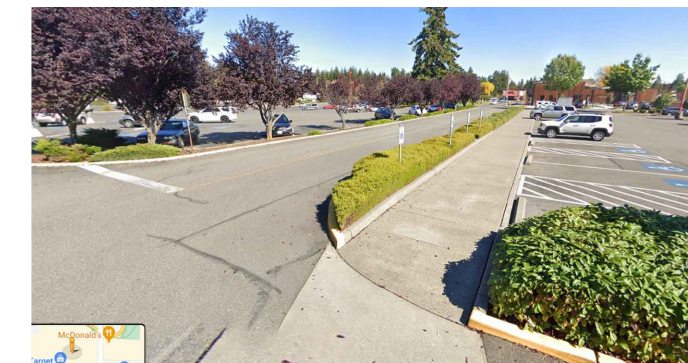

Proposed Concrete Sidewalk with Protective Elements (to match existing)

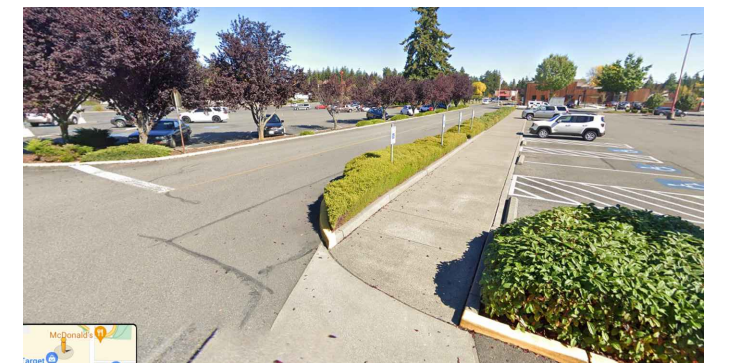

Proposed Painted Pedestrian Crosswalk



Proposed Painted Sidewalk through Parking Area



Existing Concrete Crosswalk



Proposed Concrete Crosswalk (to match existing)



Proposed Sidewalk Adjacent to Building with Plantings

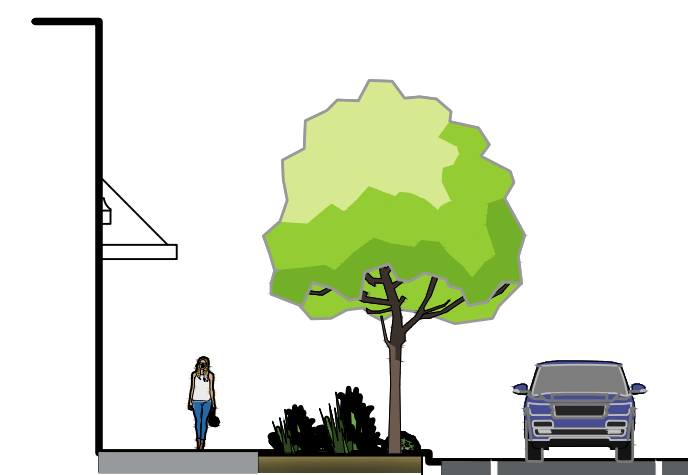

Enhanced Intersection for Pedestrian Safety per Connectivity Plan

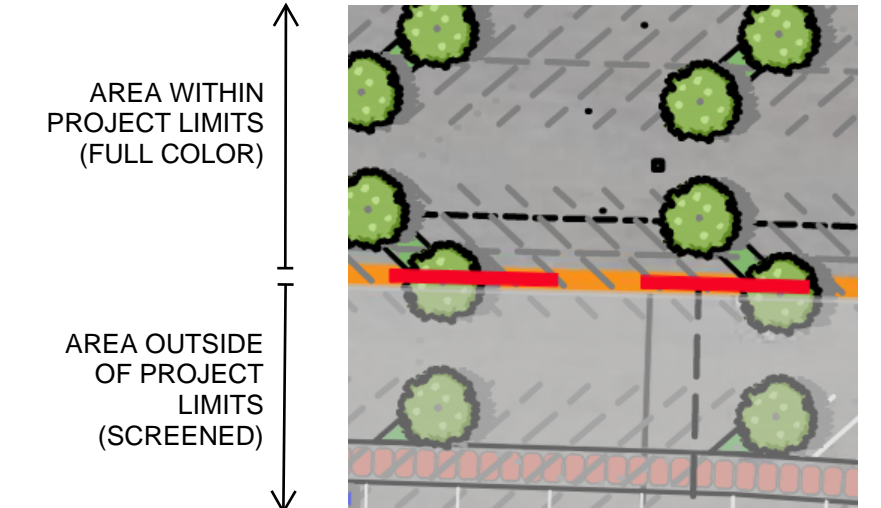
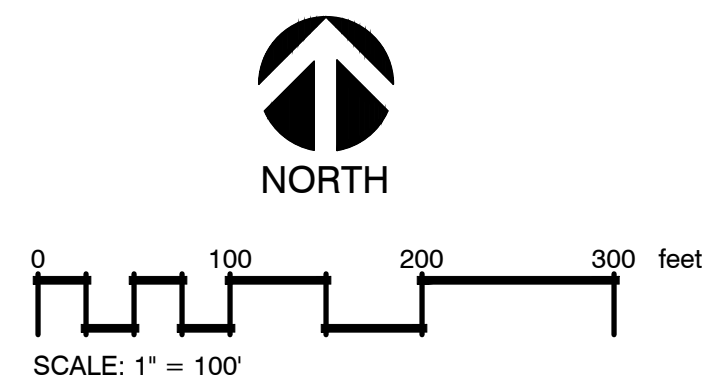
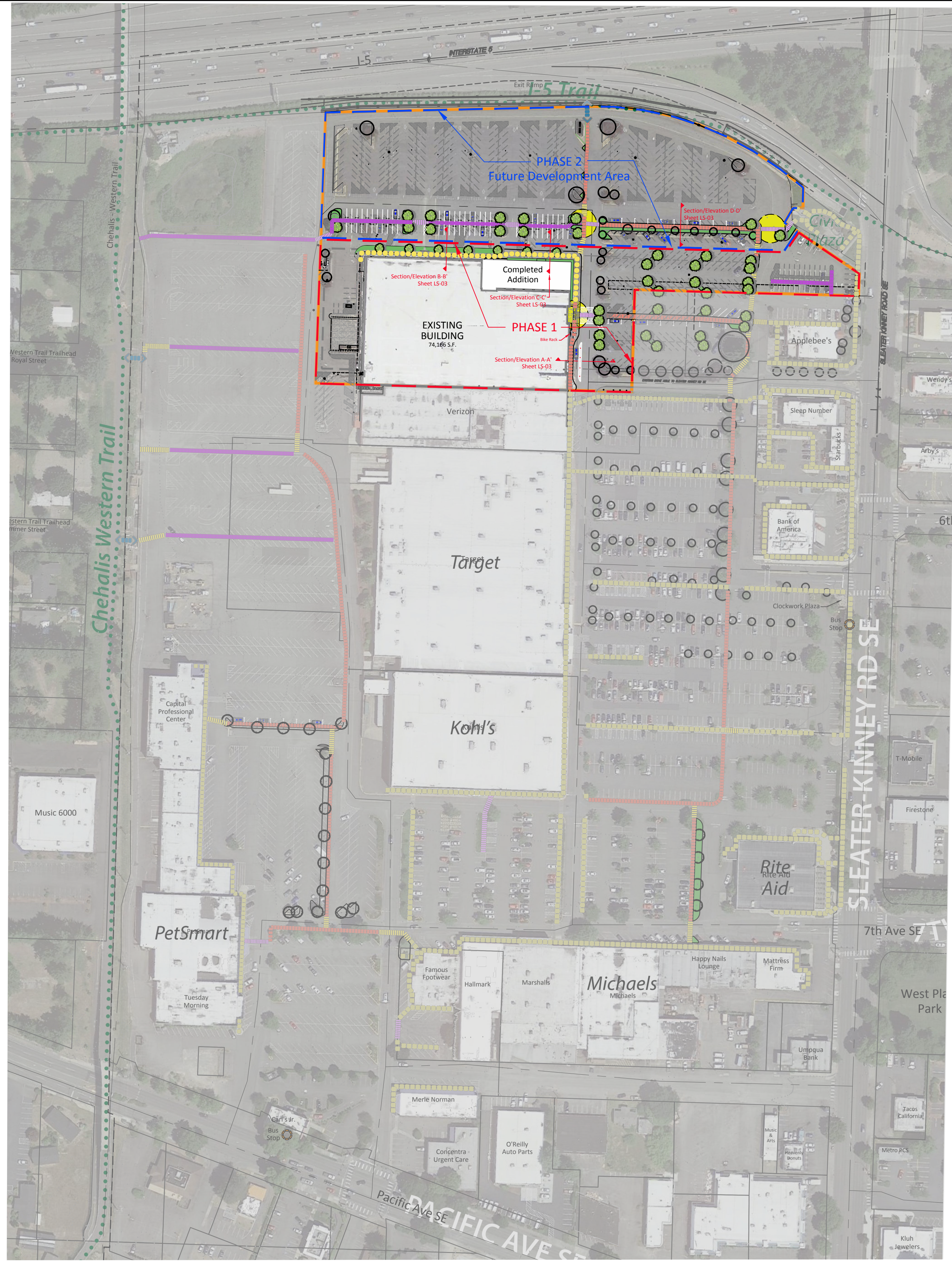

Aug 17, 2023 11:28:19am - User: engineer  
 PROJECTS\6830 TRANSFORMCO LACEY\CADD\22-000301 TRANSFORMCO LACEY\CADD\22-000301 X-BK (FROM OLD FILES).DWG

REVISIONS	DATE	BY	DESIGNED BY:	ISSUE DATE:
			A. VOS	AUGUST 2023
			DRAWN BY:	JOB No.:
			A. VOS	22-000301
			APPROVED BY:	DRAWING FILE No.:
			J. GLANDER	_22-000301 X-BK (from old files)

ALL DIMENSIONS SHOWN IN FEET UNLESS OTHERWISE DESIGNATED

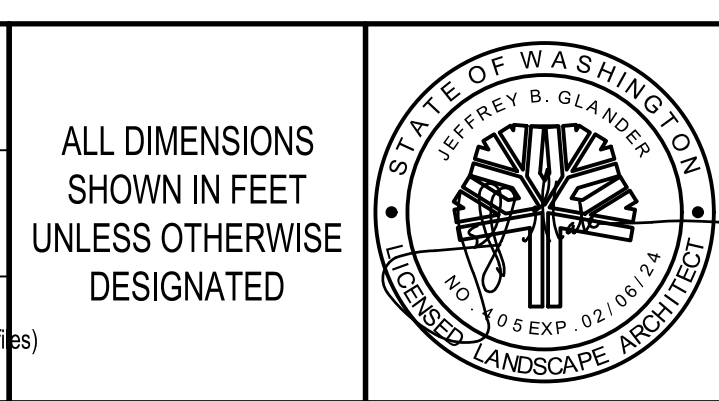

**SCJ ALLIANCE**  
 CONSULTING SERVICES  
 8730 TALLON LANE NE, SUITE 200, LACEY, WA 98516  
 P: 360.352.1465 F: 360.352.1509  
 SCJALLIANCE.COM

PROJECT NAME:  
 CONNECTIVITY PLAN  
 TRANSFORMCO  
 LACEY, WASHINGTON

CONCEPTUAL LANDSCAPE PLAN  
 SURROUNDING AREA LEVEL PLAN

DRAWING No.: LS-02  
 SHEET No.: 2 OF 3

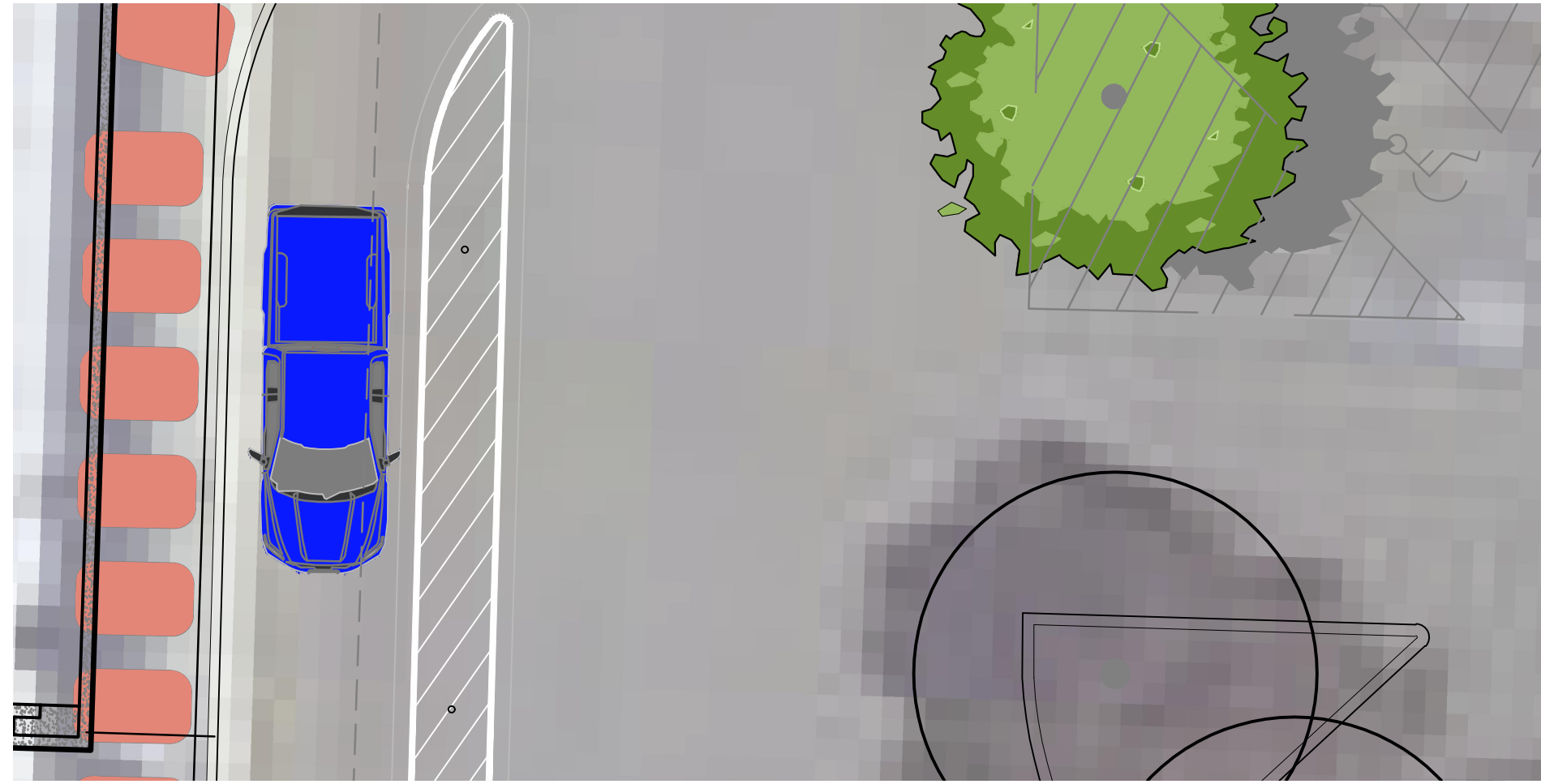

Plan View A-A': Proposed Sidewalk with Protective Elements at Loading Area

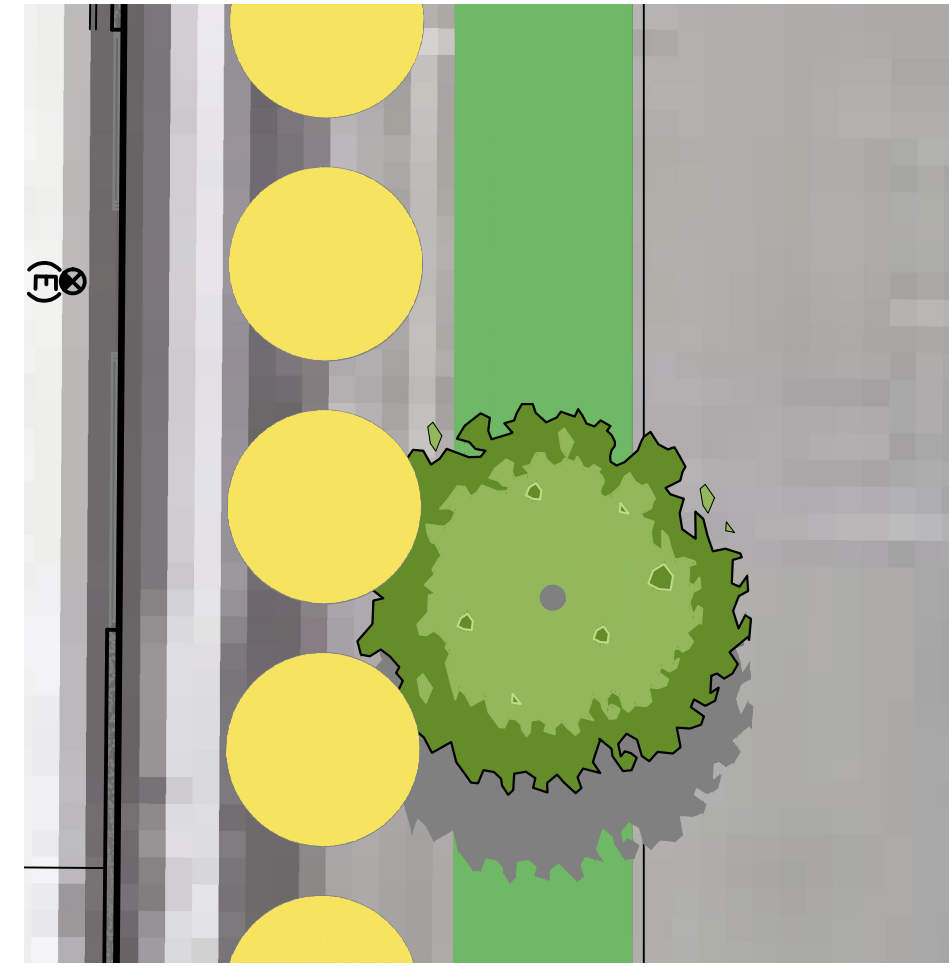

Plan View B-B': Sidewalk Adjacent to Building with Proposed Plantings

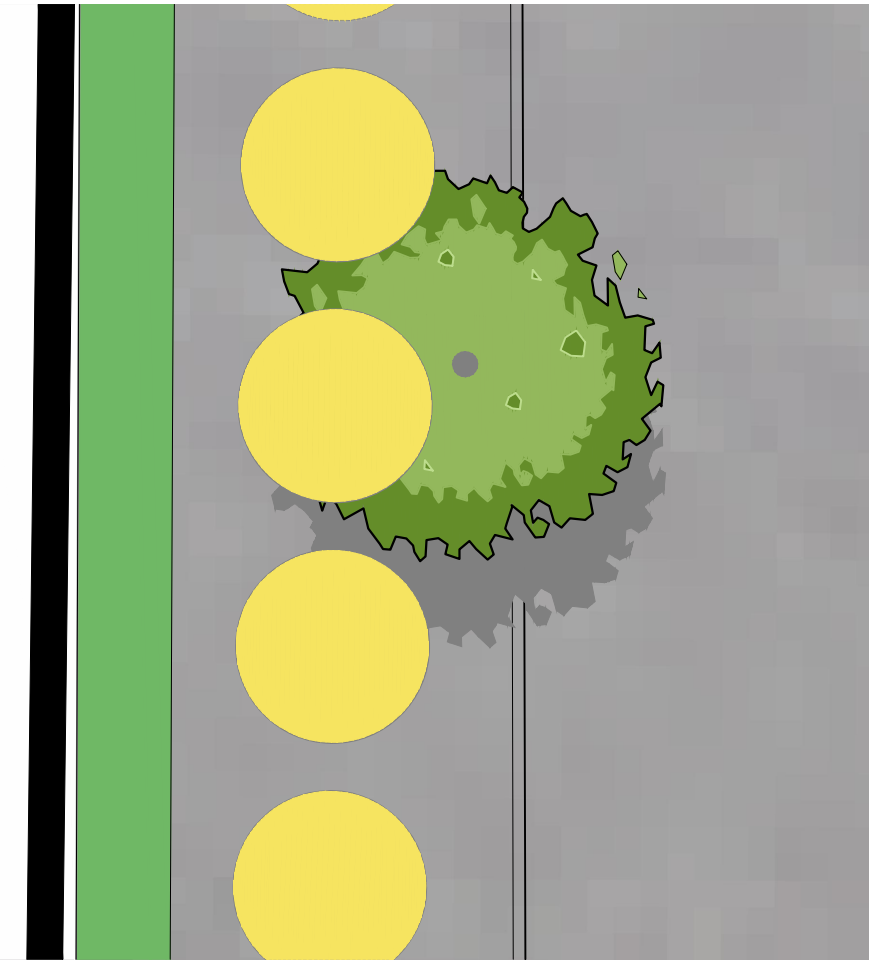

Plan View C-C': Sidewalk with Proposed Plantings Adjacent to Building

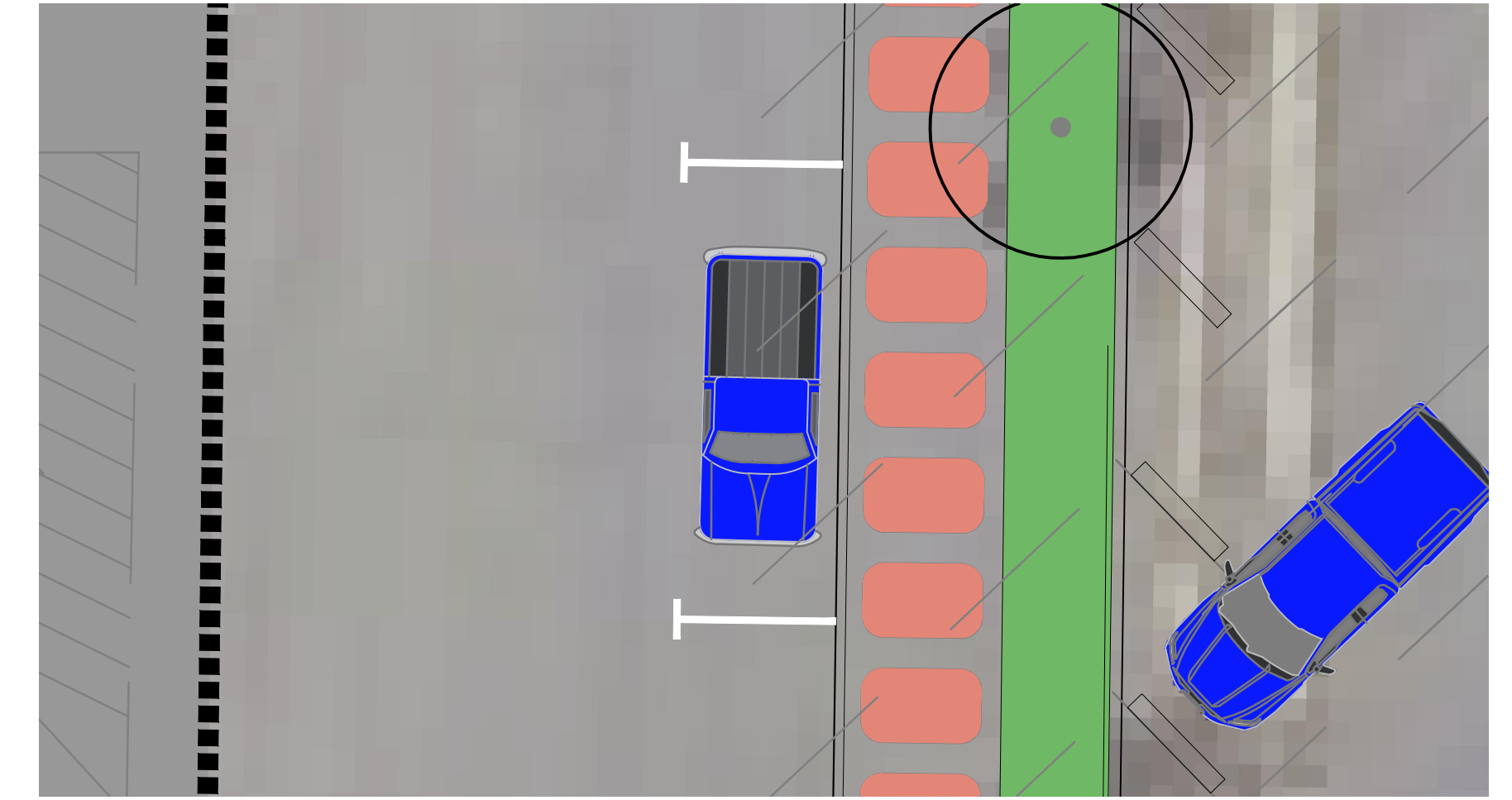

Plan View D-D': Proposed Sidewalk with Protective Elements and Parallel Parking

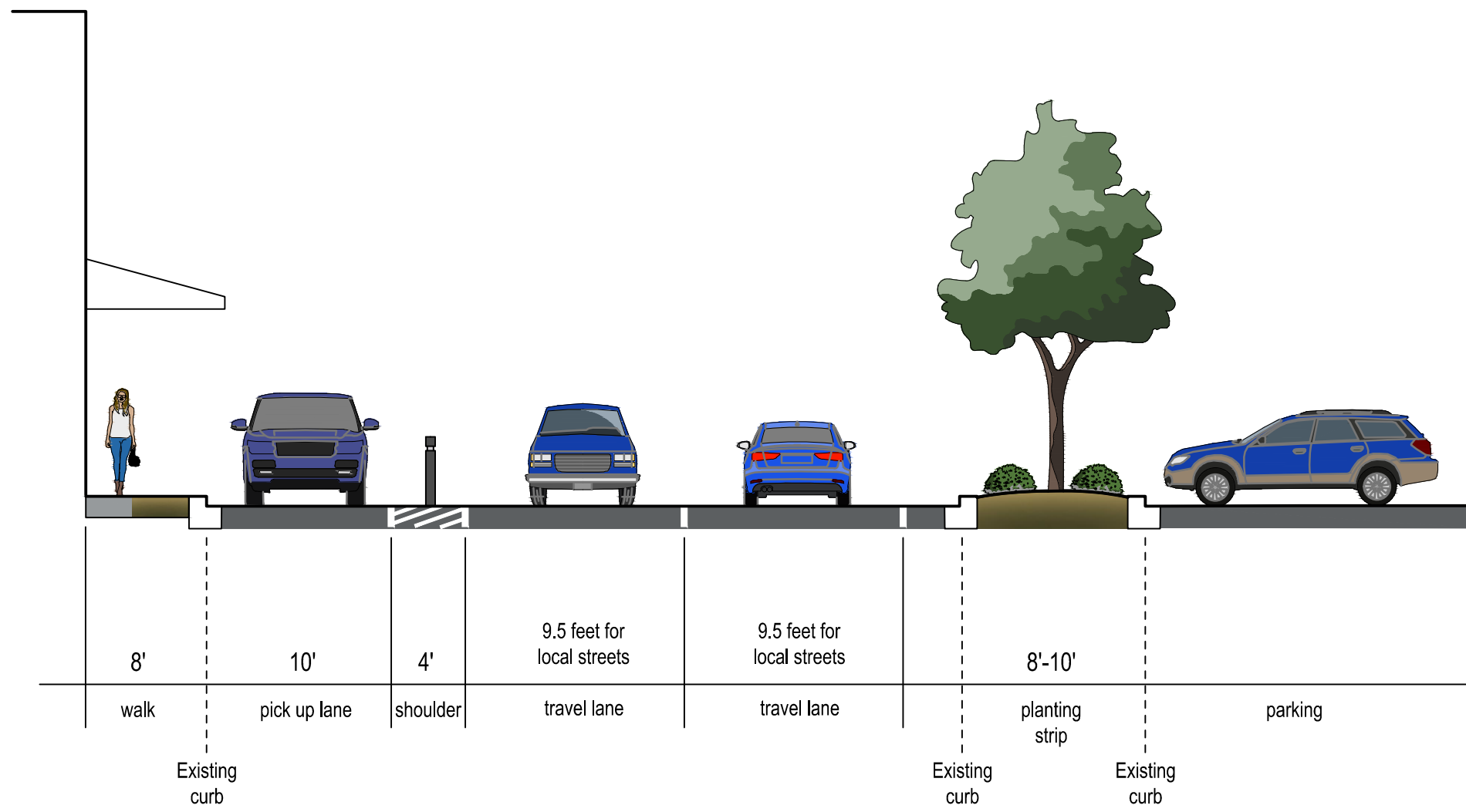

Section/Elevation A-A'

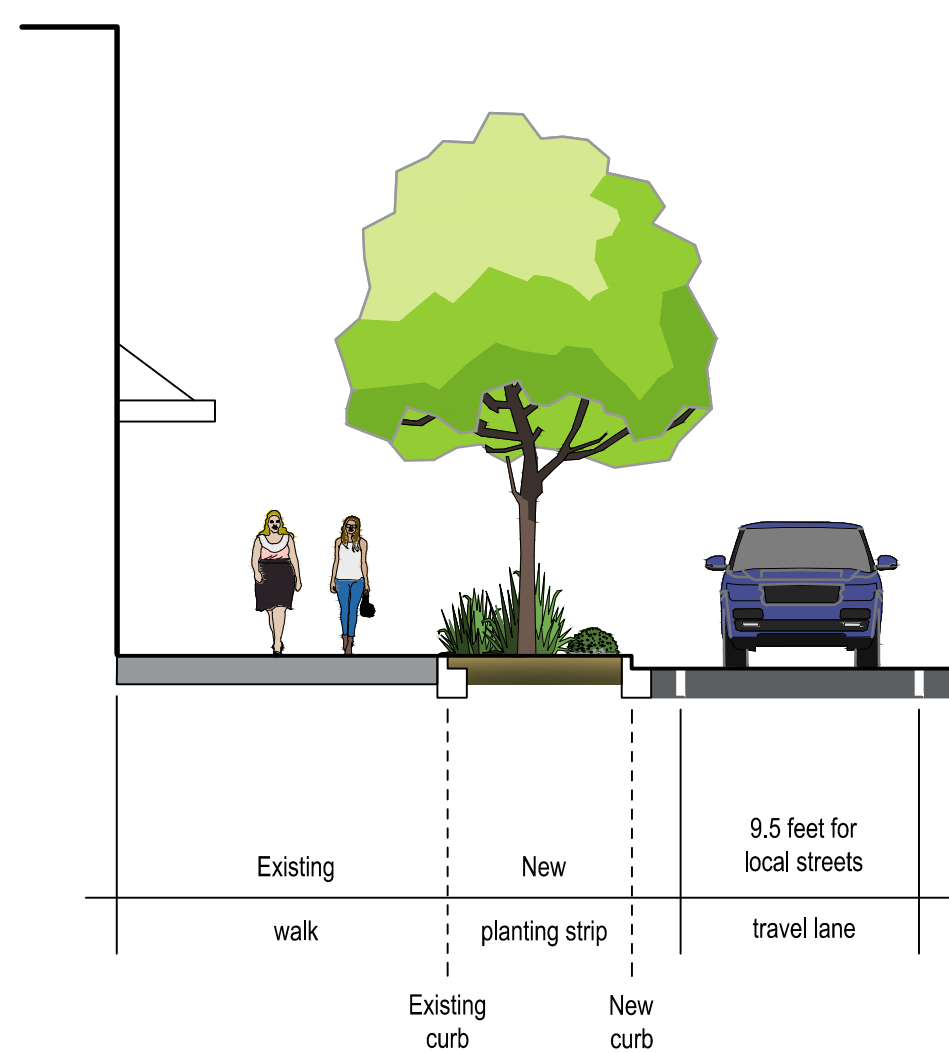

Section/Elevation B-B'

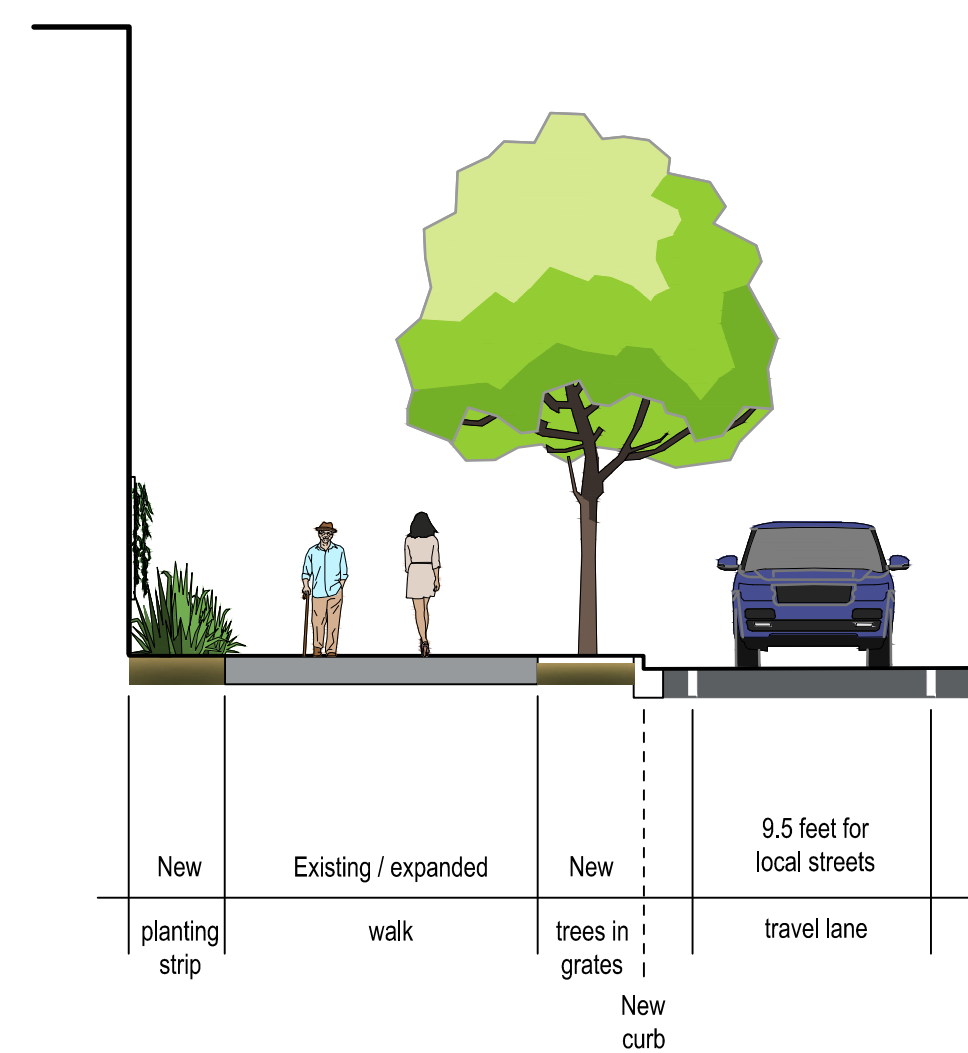

Section/Elevation C-C'

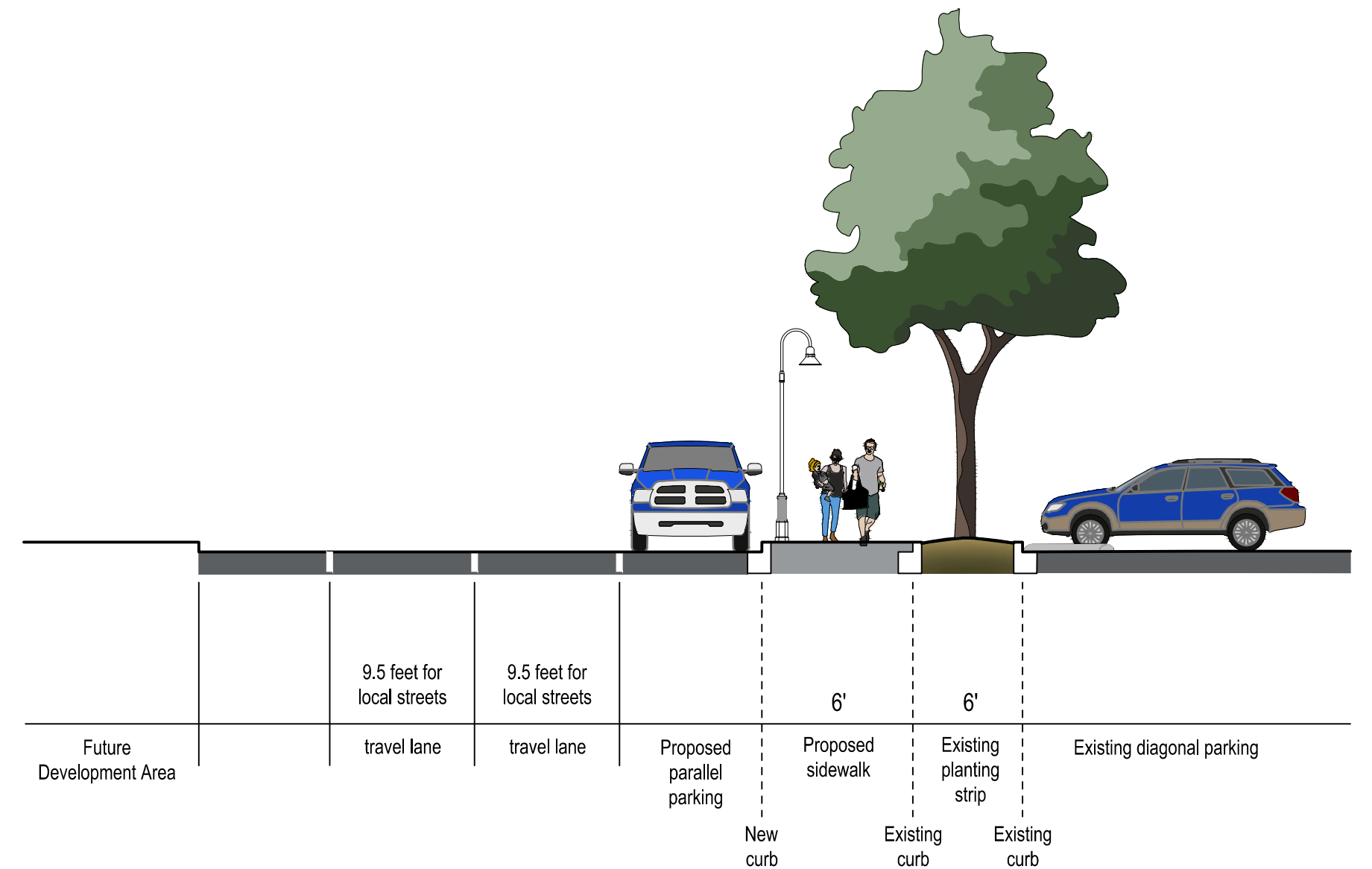

Section/Elevation D-D'

Jun 10, 2023 10:48:44am I:\user\_engines\scj\PROJECTS\22-000301\_TRANSFORMCO\_LACEY\CADD\22-000301-X-SECTIONS

REVISIONS	DATE	BY	DESIGNED BY:	ISSUE DATE:
			A. VOS	AUGUST 2023
			DRAWN BY:	JOB No.:
			A. VOS	22-000301
			APPROVED BY:	DRAWING FILE No.:
			J. GLANDER	_22-000301 X-Sect

ALL DIMENSIONS SHOWN IN FEET UNLESS OTHERWISE DESIGNATED



**SCJ ALLIANCE**  
CONSULTING SERVICES  
8730 TALLON LANE NE, SUITE 200, LACEY, WA 98516  
P: 360.352.1465 F: 360.352.1509  
SCJALLIANCE.COM

PROJECT NAME:  
**CONNECTIVITY PLAN  
TRANSFORMCO  
LACEY, WASHINGTON**

**CONCEPTUAL LANDSCAPE SECTIONS**

DRAWING No.: **LS-03**  
SHEET No.: **3 OF 3**